



# AIR FLOW, INC

*Range. Support. Experience.*



Warehouse Catalog Edition 2.0

## Table of Contents

### Fans and Ventilators

|  |         |
|--|---------|
| <u>Downblast Centrifugal Exhaust Ventilator (Model ACED)</u> | Page 4  |
| <u>Ceiling Exhaust and Inline Fan (Model GC)</u>             | Page 5  |
| <u>Broan Ceiling Exhaust Fan</u>                             | Page 5  |
| <u>Destratification Fan</u>                                  | Page 23 |

### Fan Accessories

|  |         |
|--|---------|
| <u>Gravity Backdraft Damper</u>  | Page 4  |
| <u>Low Leakage Control Damper (Model CD36)</u>                         | Page 6  |
| <u>Low Leakage Round Control Damper (Model CDRS25)</u>                 | Page 6  |
| <u>Belimo Actuators</u>  | Page 6  |
| <u>Roof Curbs 18" High / 18 GA</u>                                     | Page 7  |
| <u>Equipment Rails 18" High / 18 GA</u>                                | Page 7  |
| <u>Loading Information</u>   | Page 7  |
| <u>Pipe Curb Assembly / 18 GA</u>                                      | Page 7  |
| <u>Three Phase Combination Building Automation Starter (Model BAS)</u> | Page 21 |
| <u>Single Phase Building Automation Starter (Model BAS-1P)</u>         | Page 21 |

### Dampers and Actuators

|  |        |
|--|--------|
| <u>Gravity Backdraft Damper</u>                        | Page 4 |
| <u>Low Leakage Control Damper (Model CD36)</u>         | Page 6 |
| <u>Low Leakage Round Control Damper (Model CDRS25)</u> | Page 6 |
| <u>Belimo Actuators</u>                                | Page 6 |

### Curbs, Rails, and Pipe Portals

|   |        |
|---|--------|
| <u>Roof Curbs 18" High / 18 GA</u>      | Page 7 |
| <u>Equipment Rails 18" High / 18 GA</u> | Page 7 |
| <u>Loading Information</u>              | Page 7 |
| <u>Pipe Curb Assembly / 18 GA</u>       | Page 7 |

### Grilles, Registers, and Diffusers

|   |         |
|---|---------|
| <u>Square Plaque Diffusers (Model SPD)</u>                | Page 8  |
| <u>Square Cone Diffuser (Model SCD)</u>                   | Page 8  |
| <u>Louvered Face Directional Diffuser (Model SMD)</u>     | Page 9  |
| <u>Perforated, Lay In, Supply Diffuser (Model PDC)</u>    | Page 10 |
| <u>Perforated, Lay In, Supply Diffuser (Model PDF)</u>    | Page 10 |
| <u>Perforated, Lay In, Return Diffuser (Model PDDR)</u>   | Page 10 |
| <u>Round Cone Adjustable Diffuser (Model RCDE)</u>        | Page 11 |
| <u>Radial Volume Damper (Model VCR9)</u>                  | Page 11 |
| <u>Light Commercial Directional Diffuser (Model LCMD)</u> | Page 11 |

## Table of Contents

### Grilles, Registers, and Diffusers

|  |         |
|--|---------|
| <u>Surface Mount Supply Register (Model 520D)</u>                      | Page 14 |
| <u>Fixed Blade Return Grille (Model 530)</u>                           | Page 16 |
| <u>Spiral Mount Grilles with Air Scoops (Model SDG)</u>                | Page 15 |
| <u>Door Grilles with BF Frame (Model STG1)</u>                         | Page 18 |
| <u>Egg Crate Grille with Integral Plenum (Model ECRD)</u>              | Page 17 |
| <u>Egg Crate Grille, Lay In and Surface Mount (Model ECR/ECR-TB)</u>   | Page 17 |
| <u>Louvered Face Lay In Filtered Return Grilles (Model 530FF - TB)</u> | Page 18 |
| <u>Egg Crate Lay In Filtered Return Grilles (Model 80FF - TB)</u>      | Page 18 |
| <u>Square to Round Transition (Model STR)</u>                          | Page 19 |
| <u>Round to Round Transition (Model RTR)</u>                           | Page 19 |
| <u>Drywall Frame (Model QMF)</u>                                       | Page 19 |

### Slot Diffusers, Fixed and Adjustable

|   |         |
|---|---------|
| <u>Adjustable Slot Diffuser (Model XW)</u>                            | Page 12 |
| <u>Ice Tong Slot Diffuser (Model XC)</u>                              | Page 12 |
| <u>Fixed Blade Slot Diffuser (Model J)</u>                            | Page 13 |
| <u>Fixed Blade Slot Diffuser for Flat 9/16" Narrow Grid (Model J)</u> | Page 13 |
| <u>Fixed Blade Slot Plaster Frames (Model J)</u>                      | Page 13 |

### VAV Boxes and Coils

|   |         |
|---|---------|
| <u>Single Duct VAV Terminal Units (Model SDV)</u> | Page 20 |
| <u>Hot Water Coils for Model SDV</u>              | Page 20 |

### Flexible Duct

|  |         |
|--|---------|
| <u>Type 1 Flexible Duct</u>                                | Page 22 |
| <u>Type 6 Flexible Duct</u>                                | Page 22 |
| <u>FlexRight Elbow for Type 1 and Type 6 Flexible Duct</u> | Page 22 |

### Radiant Heat

|  |         |
|--|---------|
| <u>Hot Water Radiant Ceiling Panels</u>                        | Page 23 |
| <u>Two-Stage, Gas Fired Infrared Tube Heaters (Model DET3)</u> | Page 24 |

### Electric Heat

|   |         |
|---|---------|
| <u>Small Room Fan Forced Heaters (Model SRA)</u>        | Page 25 |
| <u>Commercial Fan Forced Wall Heaters (Model FRC)</u>   | Page 25 |
| <u>Architectural Small Wall Heaters (Model SRA1000)</u> | Page 26 |
| <u>Electric Baseboard Heaters (Model 2500)</u>          | Page 26 |

### Access Doors and Gas Detectors

|                                 |         |
|---------------------------------|---------|
| <u>Access Doors</u>             | Page 27 |
| <u>24V CO/NO2 Gas Detectors</u> | Page 23 |

# Cook

## Model ACED Downblast Centrifugal Exhaust Ventilator—Direct Drive

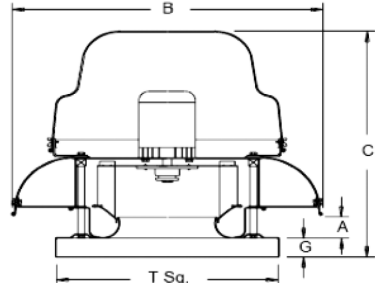

- All aluminum housing
- Backward inclined all aluminum wheel
- Welded curb cap corners
- Birdscreen
- Factory installed disconnect switch—Prewired
- Factory installed speed switch—Prewired

| Model    | CFM Range @ 0.5" SP | HP  | Voltage | B (width) | C (Height) | T (Curb Cap) | Weight | Curb Size | BDD   |
|----------|---------------------|-----|---------|-----------|------------|--------------|--------|-----------|-------|
| 90C15DH  | 100-400             | 1/8 | 115/1   | 18-3/4    | 16.8125    | 18x18        | 28     | 16.5x16.5 | 12x12 |
| 100C15DH | 250-525             | 1/8 | 115/1   | 18-3/4    | 16.8125    | 18x18        | 30     | 16.5x16.5 | 12x12 |
| 101C15D  | 350-700             | 1/8 | 115/1   | 18-3/4    | 16.8125    | 18x18        | 30     | 16.5x16.5 | 12x12 |
| 120C15D  | 600-1350            | 1/4 | 115/1   | 28-7/16   | 26.5625    | 20x20        | 67     | 18.5x18.5 | 14x14 |
| 150C10D  | 1000-1900           | 1/3 | 115/1   | 32-7/8    | 28.6875    | 24x24        | 87     | 22.5x22.5 | 18x18 |

### Gravity Backdraft Damper

Gravity dampers feature an extruded aluminum frame, aluminum blades and aluminum hinge pins with nylon bushings.

Available in sizes:

- 8x8
- 10x10
- 12x12
- 14x14
- 16x16
- 18x18
- 20x20
- 22x22
- 24x24



# Cook

## Model GC Ceiling Exhaust and Inline Fan

- Forward curved injection molded wheel
- One piece injection molded housing
- Motor isolators
- 6" round outlet with backdraft damper
- Integral disconnect switch
- Factory mounted and wired speed switch



**Gemini 124-184**



**Gemini 240-640**

| Model  | CFM @ 0.25" SP | Watts | Voltage | Sones |
|--------|----------------|-------|---------|-------|
| GC-128 | 63             | 64    | 115/1   | 1.0   |
| GC-148 | 132            | 98    | 115/1   | 2.5   |
| GC-168 | 162            | 145   | 115/1   | 3.5   |
| GC-188 | 244            | 89    | 115/1   | 6.5   |
| GC-242 | 108            | 26    | 115/1   | 1.5   |
| GC-342 | 224            | 77    | 115/1   | 4.5   |
| GC-522 | 201            | 72    | 115/1   | 2.0   |
| GC-642 | 548            | 178   | 115/1   | 4.5   |



Available accessories:

- Round duct wall caps with damper in 4", 6", 8" sizes
- 16"x8" brick vent

# Broan

## Ceiling Exhaust Fan

| Model | CFM @ 0.10" SP | Watts | Voltage | Sones | Outlet |
|-------|----------------|-------|---------|-------|--------|
| 670   | 50             | 55    | 115/1   | 3.5   | 3"     |
| 674   | 110            | 48    | 115/1   | 4.0   | 4"     |



# Ruskin

## Model CD36 Low Leakage Control Damper—Opposed Blade

- 6" x 1/2" control shaft
- 16 gauge frame
- 16 gauge 6" blades
- Blade and jamb seals

Available in sizes:

- 10x10
- 12x12
- 14x14
- 16x16
- 18x18
- 24x12
- 24x24
- 30x30
- 36x24
- 36x36
- 48x24
- 48x48



## Model CDRS25 Low Leakage Round Control Damper

Available in sizes:

- 6"
- 8"
- 10"
- 12"
- 14"
- 16"



# Belimo

## Damper Actuators

Internal & external linkage kits available



| Model    | Voltage | Aux. Switch Available | Torque    | Recommended Damper Size |
|----------|---------|-----------------------|-----------|-------------------------|
| TF24(S)  | 24V     | Yes                   | 18 in-lb  | 4.5 sqft                |
| LF24(S)  | 24V     | Yes                   | 35 in-lb  | 8.0 sqft                |
| NFB24(S) | 24V     | Yes                   | 90 in-lb  | 22 sqft                 |
| AFB24(S) | 24V     | Yes                   | 180 in-lb | 45 sqft                 |
| TF120(S) | 120V    | Yes                   | 18 in-lb  | 4.5 sqft                |
| LF120(S) | 120V    | Yes                   | 35 in-lb  | 8.0 sqft                |
| NFBUP(S) | 24-240V | Yes                   | 90 in-lb  | 22 sqft                 |
| AFBUP(S) | 24-240V | Yes                   | 180 in-lb | 45 sqft                 |

# The Pate Company

## Roof Curbs 18" High / 18 Gauge

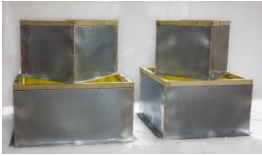

| Model | O.D.        | I.D.        | Cook Fan Sizes          |
|-------|-------------|-------------|-------------------------|
| PC-2  | 16.5"x16.5" | 13.5"x13.5" | 60, 70, 80, 90, 100     |
| PC-2  | 18.5"x18.5" | 15.5"x15.5" | 120, 135                |
| PC-2  | 22.5"x22.5" | 19.5"x19.5" | 150, 165                |
| PC-2  | 28.5"x28.5" | 25.5"x25.5" | 180, 195, 210, 225, 245 |
| PC-2  | 34.5"x34.5" | 31.5"x31.5" | 270, 300                |
| PC-2  | 40.5"x40.5" | 37.5"x37.5" | 330, 365                |

## Equipment Rails 18" High / 18 Gauge

| Model | Length | Width | Nailer |
|-------|--------|-------|--------|
| ES-2  | 2'-0"  | 6"    | 2"x6"  |
| ES-2  | 3'-0"  | 6"    | 2"x6"  |
| ES-2  | 4'-0"  | 6"    | 2"x6"  |
| ES-2  | 5'-0"  | 6"    | 2"x6"  |
| ES-2  | 6'-0"  | 6"    | 2"x6"  |
| ES-2  | 8'-0"  | 6"    | 2"x6"  |

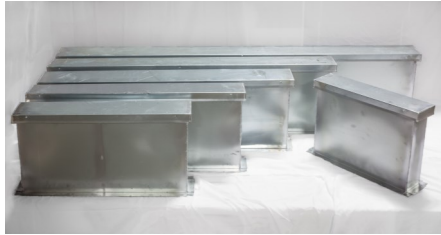

## Loading Information

| Style | Width & Height | Area IN | Moment of Inertia IN | Section Modulus IN | Maximum Allowable Concentrated Load Lbs. | Maximum Allowable End Reaction Lbs. | Maximum Allowable Intermediate Reaction Lbs. | Maximum Allowable Uniform Load Lb./Ft. |
|-------|----------------|---------|----------------------|--------------------|--|-------------------------------------|--|--|
| ES-2  | 5-1/2x18       | 1,775   | 37,800               | 4.85               | 4300                                     | 4100                                | 4100   | 1300                                   |

## Pipe Curb Assembly / 18 Gauge

| Curb Model | Curb Size O.D.   |
|------------|------------------|
| PCA-2      | 15"x15"x12" High |

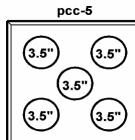
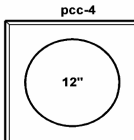
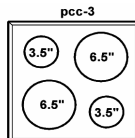
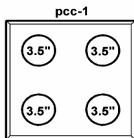

| Cap Model | Pipe Sizes                      |
|-----------|---------------------------------|
| PCC-1     | (4) 1/2"-2 7/8"                 |
| PCC-3     | (2) 1/2"-2 7/8" & (2) 3"-5 1/2" |
| PCC-4     | (1) 6"-10 3/4"                  |
| PCC-5     | (5) 1/2"-2 7/8"                 |

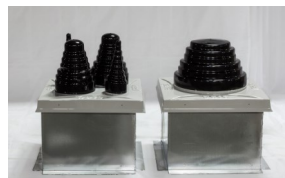

# Price

## Model (A)SPD Square Plaque Diffuser

| Neck Size | Panel Size | CFM Range |
|-----------|------------|-----------|
| 6"        | 24" x 24"  | 0-150     |
| 8"        | 24" x 24"  | 140-280   |
| 10"       | 24" x 24"  | 215-435   |
| 12"       | 24" x 24"  | 315-625   |
| 14"       | 24" x 24"  | 430-855   |



- Steel (SPD) or Aluminum (ASPD) Construction
- White Powder Coat Finish
- Surface Mount Frames and Dampers Available

## Model (A)SCD Square Cone Diffuser



| Neck Size | Panel Size | CFM Range |
|-----------|------------|-----------|
| 6"        | 12" x 12"  | 0-150     |
| 8"        | 12" x 12"  | 140-280   |
| 6"        | 24" x 24"  | 0-150     |
| 8"        | 24" x 24"  | 140-280   |
| 10"       | 24" x 24"  | 215-435   |
| 12"       | 24" x 24"  | 315-625   |
| 14"       | 24" x 24"  | 430-855   |
| 15"       | 24" x 24"  | 450-930   |

- Steel (SCD) or Aluminum (ASCD) Construction
- White Powder Coat Finish
- 360 Degree Fixed Air Pattern
- Removable Core—Without Tools
- Surface Mount Frames and Dampers Available

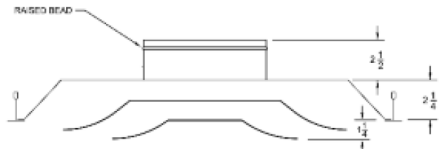



# Price

## Model SMD Louvered Face Directional Diffuser

| Neck Size | Panel Size | CFM Range |
|-----------|------------|-----------|
| 6"x6"     | -          | 0-200     |
| 9"x9"     | -          | 210-450   |
| 12"x12"   | -          | 400-775   |
| 15"x15"   | -          | 625-1050  |
| 6"x6"     | 24"x24"    | 0-200     |
| 9"x9"     | 24"x24"    | 210-450   |
| 12"x12"   | 24"x24"    | 400-775   |
| 15"x15"*  | 24"x24"    | 625-1050  |

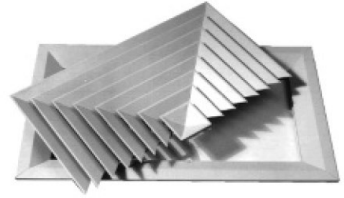
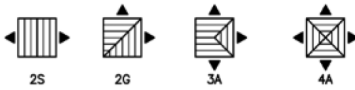

**Type 6**  
Surface Mount – Beveled

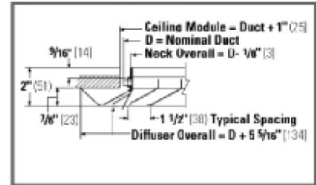

**Type 3P**  
Lay-In Inverted Tee 1" (25) Panel

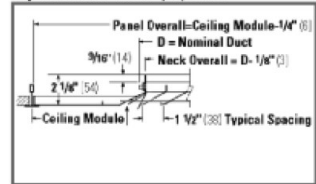

- Steel Construction
- White Powder Coat Finish
- Spring Loaded Removable Core
- Core Styles for 2-, 3-, 4-Way Throw
- Border 3P—Lay In Ceiling
- Border 6—Beveled Frame Surface Mount
- Square to Round Adaptors and Surface Mount Frames Available

\*Available in 4-way aluminum construction

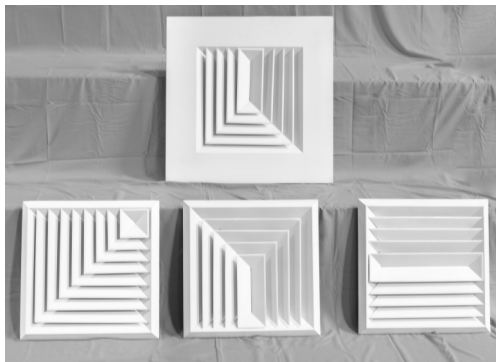

# Price

## Model PDC Perforated Supply Diffuser with Neck Mounted Adjustable Curved Blades—Lay In

| Neck Size | Panel Size | CFM Range |
|-----------|------------|-----------|
| 6"        | 24" x 24"  | 0-150     |
| 8"        | 24" x 24"  | 140-280   |
| 10"       | 24" x 24"  | 215-435   |
| 12"       | 24" x 24"  | 315-625   |
| 14"       | 24" x 24"  | 430-855   |

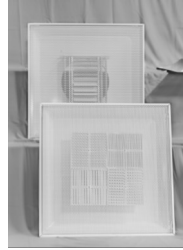

- Steel Construction
- White Powder Coat Finish
- Hinged Removable Face
- Adjustable Deflectors
- Surface Mount Frames and Dampers Available

## Model PDF Perforated Supply Diffuser with Face Mounted Adjustable Pattern Deflectors—Lay In

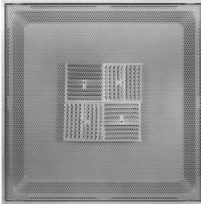

| Neck Size | Panel Size | CFM Range |
|-----------|------------|-----------|
| 6"        | 24" x 24"  | 0-150     |
| 8"        | 24" x 24"  | 140-280   |
| 10"       | 24" x 24"  | 215-435   |
| 12"       | 24" x 24"  | 315-625   |
| 14"       | 24" x 24"  | 430-855   |

- Steel Construction
- White Powder Coat Finish
- Hinged Removable Face
- Adjustable Deflectors
- Surface Mount Frames and Dampers Available

## Model PDDR Perforated Return / Transfer / Exhaust Grilles

| Neck Size | Panel Size | CFM Range |
|-----------|------------|-----------|
| 6"        | 24" x 24"  | 0-125     |
| 8"        | 24" x 24"  | 70-210    |
| 10"       | 24" x 24"  | 110-330   |
| 12"       | 24" x 24"  | 155-475   |
| 14"       | 24" x 24"  | 205-625   |
| 16"       | 24" x 24"  | 245-800   |
| 22" x 22" | 24" x 24"  | 670-2000  |
| 22"x10"   | 24"x12"    | 300-900   |

- Steel Construction
- White Powder Coat Finish
- Hinged Removable Face
- Surface Mount Frames and Dampers Available



**Model RCDE Round Cone Adjustable Diffuser**



| Inlet Size | Outside Diameter | CFM Range |
|------------|------------------|-----------|
| 6"         | 11-1/8"          | 80-160    |
| 8"         | 14-3/4"          | 140-280   |
| 10"        | 18-1/4"          | 220-435   |
| 12"        | 22"              | 315-630   |
| 14"        | 26"              | 425-850   |

- Steel Construction
- White Powder Coat Finish
- Radial Dampers Available
- 360 Degree Adjustable Air Pattern

**Model VCR9 Radial Volume Damper**

Available in sizes:

- 6"
- 8"
- 10"
- 12"
- 14"

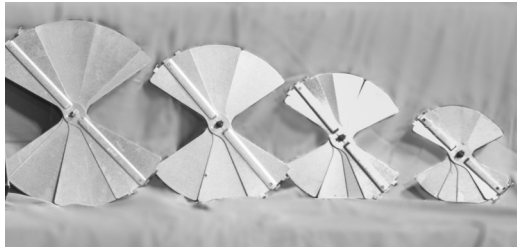

**Model LCMD Light Commercial Directional Diffuser**



- Steel Construction
- White Powder Coat Finish
- All are 4-Way Throw
- Surface mount with screwholes

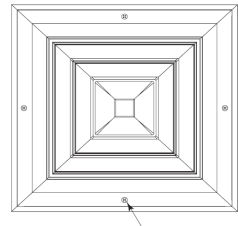

**Surface Mount**

| Neck Size | Panel Size | CFM Range |
|-----------|------------|-----------|
| 6"x6"     | -          | 0-200     |
| 8"x8"     | -          | 210-450   |
| 10"x10"   | -          | 400-775   |
| 12"x12"   | -          | 625-1050  |

# Raymon-Donco

## Model XW Adjustable Slot Diffuser

| Model | Length | Slots  | Inlet | With Center Notch | CFM Range |
|-------|--------|--------|-------|-------------------|-----------|
| XW20  | 24"    | 2-slot | 6"    | -                 | 75-150    |
| XW20  | 24"    | 2-slot | 8"    | -                 | 75-150    |
| XW20  | 48"    | 2-slot | 6"    | Yes               | 125-175   |
| XW20  | 48"    | 2-slot | 8"    | Yes               | 175-250   |
| XW20  | 48"    | 2-slot | 10"   | Yes               | 150-275   |
| XW40  | 48"    | 4-slot | 10"   | Yes               | 275-500   |
| XW40  | 48"    | 4-slot | 12"   | Yes               | 275-500   |



- Oval inlets and low profile plenums
- White face and T-bars
- Black pattern deflectors
- Integral side-T's

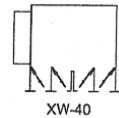
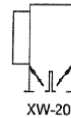
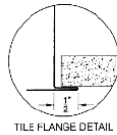

## Model XC Ice Tong Adjustable Slot Diffuser



| Model | Length | Slots  | Inlet | With Center Notch | CFM Range |
|-------|--------|--------|-------|-------------------|-----------|
| XC20  | 24"    | 2-slot | 6"    | -                 | 75-150    |
| XC20  | 24"    | 2-slot | 8"    | -                 | 75-150    |
| XC20  | 48"    | 2-slot | 6"    | Yes               | 125-175   |
| XC20  | 48"    | 2-slot | 8"    | Yes               | 175-250   |
| XC20  | 48"    | 2-slot | 10"   | Yes               | 250-300   |
| XC40  | 48"    | 4-slot | 10"   | Yes               | 300-475   |
| XC40  | 48"    | 4-slot | 12"   | Yes               | 300-475   |



- Oval inlets and low profile plenums
- White face and T-bars
- Black pattern deflectors
- Integral side-T's

# Raymon-Donco

## Model J Fixed Blade Slot Diffuser

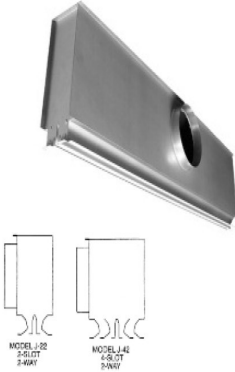

| Model | Length | Slots  | Inlet | Available with Center Notch | CFM Range |
|-------|--------|--------|-------|-----------------------------|-----------|
| J22   | 24"    | 2-slot | 6"    | -                           | 80-160    |
| J22   | 24"    | 2-slot | 8"    | -                           | 80-160    |
| J22   | 48"    | 2-slot | 6"    | Yes                         | 125-175   |
| J22   | 48"    | 2-slot | 8"    | Yes                         | 175-250   |
| J22   | 48"    | 2-slot | 10"   | Yes                         | 250-325   |
| J42   | 48"    | 4-slot | 10"   | Yes                         | 325-500   |
| J42   | 48"    | 4-slot | 12"   | Yes                         | 325-500   |

- Oval inlets and low profile plenums
- White face
- Integral side-T's

## Model J Fixed Blade Slot Diffuser for Flat 9/16" Narrow Grid

| Model | Length | Slots  | Inlet | Available with Center Notch | CFM Range |
|-------|--------|--------|-------|-----------------------------|-----------|
| J22   | 24"    | 2-slot | 6"    | -                           | 80-160    |
| J22   | 48"    | 2-slot | 8"    | Yes                         | 175-250   |
| J22   | 48"    | 2-slot | 10"   | Yes                         | 250-325   |

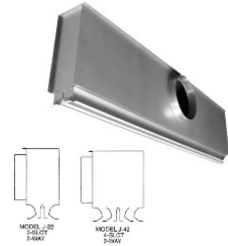

- Oval inlets and low profile plenums
- White face
- Integral side-T's

## Model J Fixed Blade Slot Plaster Frames



| Model | Length | Slots  | Ceiling Opening |
|-------|--------|--------|-----------------|
| JF22  | 24"    | 2-slot | 24.75"x4.75"    |
| JF22  | 48"    | 2-slot | 48.75"x4.75"    |
| JF42  | 48"    | 4-slot | 48.75"x7.25"    |

- White finish
- Mounting clips

# Price

## Model 520D—Surface Mount Supply Register

Width

|        | 6"  | 8" | 10" | 12" | 14" | 16" | 18" | 20" | 22" | 24" | 30" | 36" |   |
|--------|-----|----|-----|-----|-----|-----|-----|-----|-----|-----|-----|-----|---|
| Height | 4"  | ✓  | ✓   | ✓   | ✓   |     |     |     |     |     |     |     |   |
|        | 6"  | ✓  | ✓   | ✓   | ✓   | ✓   | ✓   | ✓   |     | ✓   |     | ✓   |   |
|        | 8"  |    | ✓   | ✓   | ✓   | ✓   | ✓   |     |     | ✓   | ✓   |     |   |
|        | 10" |    |     | ✓   | ✓   | ✓   | ✓   | ✓   |     | ✓   |     |     |   |
|        | 12" |    |     |     | ✓   | ✓   | ✓   | ✓   |     | ✓   | ✓   | ✓   |   |
|        | 14" |    |     |     |     | ✓   |     |     |     | ✓   |     |     |   |
|        | 16" |    |     |     |     |     | ✓   |     |     | ✓   |     |     |   |
|        | 18" |    |     |     |     |     |     | ✓   |     |     | ✓   |     | ✓ |
|        | 20" |    |     |     |     |     |     |     |     |     |     |     |   |
|        | 22" |    |     |     |     |     |     |     |     |     |     |     |   |
|        | 24" |    |     |     |     |     |     |     |     |     | ✓   |     | ✓ |

- Steel construction with adjustable blades
- Double deflection—3/4" spacing
- Opposed blade damper
- White powder coat finish

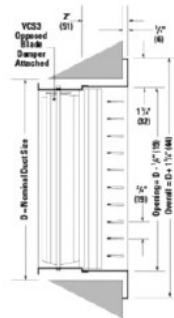
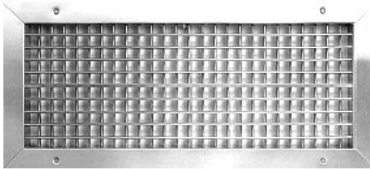

**Model SDG Spiral Mount Grilles with Air Scoops**

| Size                     | CFM (*) | Throw<br>(150-100-50 fpm) | NC |
|--------------------------|---------|---------------------------|----|
| 10"x4"                   | 175     | 10 - 14 - 20              | 21 |
| 12"x4"                   | 205     | 11 - 15 - 22              | 21 |
| 14"x4"                   | 250     | 12 - 17 - 23              | 22 |
| 16"x4"                   | 270     | 13 - 18 - 25              | 22 |
| 18"x4"                   | 310     | 13 - 19 - 27              | 23 |
| 20"x4"                   | 365     | 15 - 20 - 29              | 24 |
| 24"x4"                   | 415     | 16 - 22 - 31              | 24 |
| (*) CFM based on 800 FPM |         |                           |    |

- Steel construction with adjustable blades
- Double deflection—  
3/4" spacing
- Mill finish

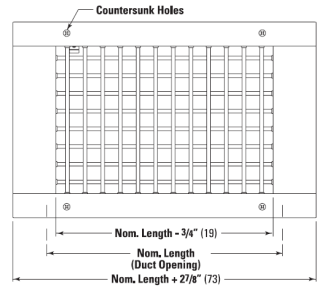

| Duct Size (in) | Min. Nom. Width (in) | Max. Nom. Width (in) |
|----------------|----------------------|----------------------|
| 8" - 13"       | -                    | 4"                   |
| 14" - 21"      | 4"                   | 6"                   |
| 22" - 31"      | 4"                   | 8"                   |
| 32" - 41"      | 4"                   | 10"                  |
| 42" - Over     | 4"                   | 12"                  |

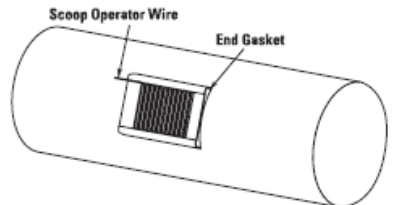
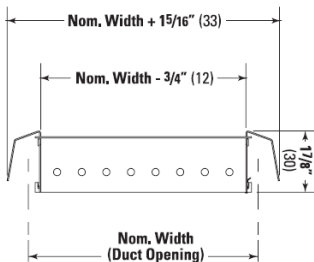

# Price

## Model 530—Fixed Blade Return Grille

Width

|        | 6"  | 8" | 10" | 12" | 14" | 16" | 18" | 20" | 22" | 24" | 30" | 36" | 48" |   |
|--------|-----|----|-----|-----|-----|-----|-----|-----|-----|-----|-----|-----|-----|---|
| Height | 4"  | ✓  | ✓   | ✓   | ✓   |     |     |     |     |     |     |     |     |   |
|        | 6"  | ✓  | ✓   | ✓   | ✓   | ✓   | ✓   |     | ✓   | ✓   |     |     |     |   |
|        | 8"  |    | ✓   | ✓   | ✓   | ✓   |     |     |     | ✓   |     |     |     |   |
|        | 10" |    |     | ✓*  | ✓   | ✓   | ✓   |     |     | ✓   |     |     |     |   |
|        | 12" |    |     |     | ✓   | ✓   | ✓   | ✓   |     |     | ✓   | ✓   | ✓   |   |
|        | 14" |    |     |     |     | ✓   | ✓   |     |     |     |     |     |     |   |
|        | 16" |    |     |     |     |     | ✓   |     |     |     |     |     |     |   |
|        | 18" |    |     |     |     |     |     | ✓   |     |     | ✓   | ✓   | ✓   |   |
|        | 20" |    |     |     |     |     |     |     | ✓   |     |     |     |     |   |
|        | 22" |    |     |     |     |     |     |     |     | ✓   |     |     |     |   |
|        | 24" |    |     |     |     |     |     |     |     |     | ✓   | ✓   | ✓   | ✓ |

- Steel construction with fixed blades
- 45 degree deflection—3/4" spacing
- B12 White powder coat finish

| Lay In Sizes (Steel or Aluminum) |            |
|----------------------------------|------------|
| Neck Size                        | Panel Size |
| 22"x10"                          | 24"x12"    |
| 22"x22" *                        | 24"x24"    |
| 22"x46"                          | 24"x48"    |

\* Sightproof Model RAME available

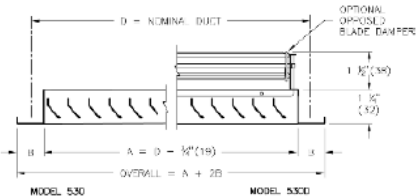



# Raymon-Donco

## Model ECRD Egg Crate Grille with Integral Plenum

| Neck Size | Module Size |
|-----------|-------------|
| 6" Round  | 24"x12"     |
| 8" Round  | 24"x12"     |
| 10" Round | 24"x12"     |
| 6" Round  | 24"x24"     |
| 8" Round  | 24"x24"     |
| 10" Round | 24"x24"     |
| 12" Round | 24"x24"     |
| 14" Round | 24"x24"     |
| 16" Round | 24"x24"     |
| 18" Round | 24"x24"     |
| 20" Round | 24"x24"     |

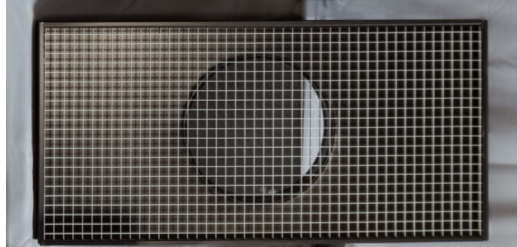

- Lay In Egg Crate Grille with Integral Plenum and 1/2"x1/2"x1/2" Aluminum Core
- 2-1/2" Tall Collar with Raised Bead
- White Powder Coat Finish on Core—Pre-Finished Black Interior on Plenum
- Surface Mount Frames and Dampers Available

## Model ECR (TB) Egg Crate Grille

| Lay In Sizes: |            | Surface Mount Sizes: |
|---------------|------------|----------------------|
| Neck Size     | Panel Size | Neck Size            |
| 22"x6"        | 24"x8"     | 6"x6"                |
| 22"x10"       | 24"x12"    | 8"x8"                |
| 22"x22"       | 24"x24"    | 10" x10"             |
| 46"x22"       | 48"x24"    | 12"x12"              |
|               |            | 14"x14"              |
|               |            | 16"x16"              |
|               |            | 18"x18"              |
|               |            | 22"x22"              |
|               |            | 24"x12"              |
|               |            | 24"x24"              |

- Lay In (TB) or Surface Mount (SM) Egg Crate Grille with 1/2"x1/2"x1/2" Aluminum Core
- White Powder Coat Finish
- Surface Mount Frames Available



# Price

## Model STG1 Door Grilles with BF Frame

Available in sizes:

- 10"x4"
- 12"x12"
- 14"x14"
- 18"x12"
- 24"x12"
- 24"x18"
- 24"x24"

- Silver powder coat finish
- Steel construction
- Telescoping frame

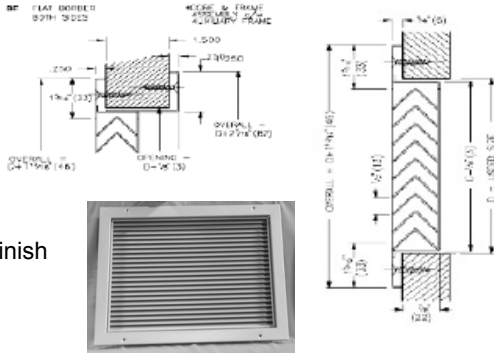

## Model 530FF-TB Louvered Face Filtered Return Grilles—Lay In

5/8" (16) Blade Spacing, 45° Deflection 530FF / 630FF

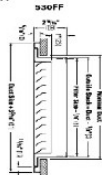
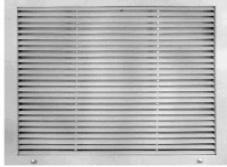

Available in sizes: 20"x20" - 24"x24" Lay In

- Steel Construction
- White Powder Coat Finish
- Fits 2" Filter
- Filters 30%

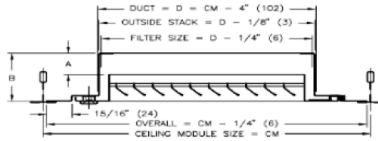

## Model 80FF-TB Egg Crate Filtered Return Grilles—Lay In

Available in sizes: 20"x20" - 24"x24" Lay In

- Aluminum Construction
- White Powder Coat Finish
- Fits 2" Filter
- Filters 30%

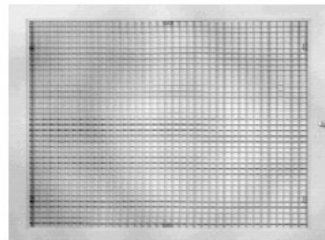
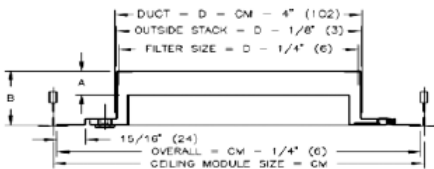

# Raymon-Donco

## Model STR Square to Round Transition

|         | 5" | 6" | 8" | 10" | 12" | 14" | 16" | 18" | 20" |
|---------|----|----|----|-----|-----|-----|-----|-----|-----|
| 6"x6"   | ✓  | ✓  |    |     |     |     |     |     |     |
| 8"x8"   |    | ✓  | ✓  |     |     |     |     |     |     |
| 9"x9"   |    | ✓  | ✓  |     |     |     |     |     |     |
| 10"x10" |    | ✓  | ✓  | ✓   |     |     |     |     |     |
| 12"x12" |    | ✓  | ✓  | ✓   | ✓   |     |     |     |     |
| 14"x14" |    |    | ✓  | ✓   | ✓   | ✓   |     |     |     |
| 15"x15" |    |    | ✓  | ✓   | ✓   | ✓   |     |     |     |
| 16"x16" |    |    |    | ✓   | ✓   | ✓   | ✓   |     |     |
| 18"x18" |    |    | ✓  | ✓   | ✓   | ✓   | ✓   |     |     |
| 22"x10" |    | ✓  | ✓  | ✓   |     |     |     |     |     |
| 22"x22" |    | ✓  | ✓  | ✓   | ✓   | ✓   | ✓   | ✓   | ✓   |



- 24GA galvanized construction
- 2-1/2" tall collar with raised bead
- Pre-finished black

## Model RTR Round to Round Transition

- 24GA galvanized construction
- 2-1/2" tall collar with raised bead
- Pre-finished black

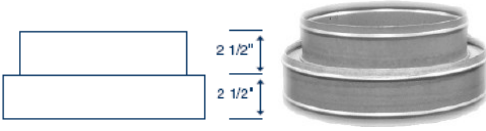

| SIZES                  |
|------------------------|
| 8" round to 6" round   |
| 10" round to 8" round  |
| 12" round to 10" round |
| 14" round to 12" round |
| 15" round to 12" round |

## Model QMF Drywall Frame

| SIZE    | ROUGH IN OPENING  |
|---------|-------------------|
| 12"X12" | 12.375" X 12.375" |
| 24"X12" | 24.375" X 12.375" |
| 24"X24" | 24.375" X 24.375" |
| 48"X24" | 48.375" X 24.375" |

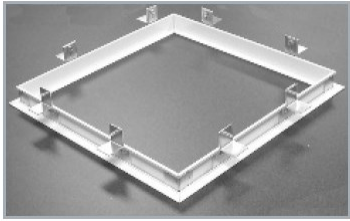

\* White Powder Coat Finish

# Price

## Model SDV5 Single Duct VAV Terminal Units

- 1/2" thick min 1.5 lb insulation
- 22GA zinc-coated steel housing
- Mechanically sealed and gasketed
- Leak resistant construction
- Slip and drive discharge
- Optional fiber free liner available.
- Optional access door available.
- Pneumatic controls available.

| INLET   | OUTLET    | LENGTH  | CFM RANGE |
|---------|-----------|---------|-----------|
| 6"      | 12"X8"    | 20-1/8" | 0-450     |
| 8"      | 12"X10"   | 20-1/8" | 0-800     |
| 10"     | 14"X12.5" | 20-1/8" | 0-1350    |
| 12"     | 16"X15"   | 20-1/8" | 0-2100    |
| 14"     | 20"X17.5" | 23-5/8" | 0-300     |
| 16"     | 24"X18"   | 23-5/8" | 0-4000    |
| 24"X16" | 38"X18"   | 19"     | 0-8000    |

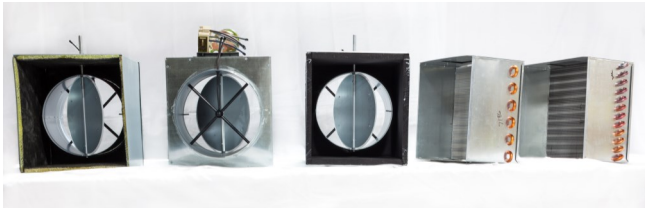
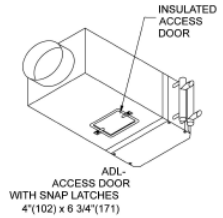
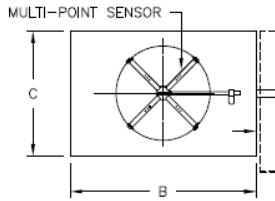

## Hot Water Coils for Model SDV5

| VAV Size | Coil Width | Coil Height | Coil Length | 1 Row | 2 Row |
|----------|------------|-------------|-------------|-------|-------|
| 6"       | 12"        | 8"          | 9"          | ✓     | ✓     |
| 8"       | 12"        | 10"         | 9"          | ✓     | ✓     |
| 10"      | 14"        | 12.5"       | 9"          | ✓     | ✓     |
| 12"      | 16"        | 15"         | 9"          | ✓     | ✓     |
| 14"      | 20"        | 17.5"       | 9"          | ✓     | ✓     |
| 16"      | 24"        | 18"         | 9"          | ✓     | ✓     |
| 24" x16" | 38"        | 18"         | 9"          | ✓     | ✓     |

# Franklin Controls

## Model BAS Smartstart Starters

### Combination Versions Include Disconnect

- Motor circuit protection disconnect provides branch and short circuit protection
- High interrupting ratings for maximum electrical system compatibility
- No fuses required—save time and money
- Lockable handle for safety

### Specifications

- Starter Type: Building Automation Starter
- Standard or Combination
- UL Type 1 or UL Type 4/12 Enclosure
- User Interface
- Hands-Off-Auto keypad with LEDs
- Watertight membrane
- LED pilot lights
- Hand, Off, Auto, Run Overload



### Three Phase Combination Building Automation Starters

| Model #          | 208V       | 230V       | 460V         |
|------------------|------------|------------|--------------|
| BAS1-9/P-G1.6-40 | -          | -          | 1/2 - 3/4 HP |
| BAS1-9/P-G2.5-40 | 1/2 HP     | 1/2 HP     | 1 HP         |
| BAS1-9/P-G4-40   | 3/4 HP     | 3/4 HP     | 1.5 - 2 HP   |
| BAS1-9/P-G6-40   | 1 HP       | 1 - 1.5 HP | 3 HP         |
| BAS1-18/P-G8-40  | 1.5 - 2 HP | 2 HP       | 5 HP         |
| BAS1-18/P-G10-40 | 2 HP       | 3 HP       | 5 HP         |
| BAS1-18/P-G13-40 | 3 HP       | 3 HP       | 7.5 HP       |
| BAS1-18/P-G17-40 | -          | 5 HP       | 10 HP        |
| BAS1-32/P-G22-40 | 5 HP       | 7.5 HP     | 15 HP        |
| BAS1-32/P-G26-40 | 7.5 HP     | 7.5 HP     | 15 HP        |
| BAS1-32/P-G32-40 | 10 HP      | 10 HP      | 20 HP        |

### Model BAS-1P Starters

#### Single Phase Combination Building Automation Starters

- On/Off Disconnect Switch with Recessed Hand/Auto Modes
- Run Status Verification
- Voltage & Dry Inputs for Auto Run Command
- Wide Range Class 10 Electronic Overload

| Model # | 120V        | 230V        |
|---------|-------------|-------------|
| BAS-1P  | 1/10 - 1 HP | 1/10 - 1 HP |



# Flexmaster

## Flexmaster Type 1 Flexible Duct

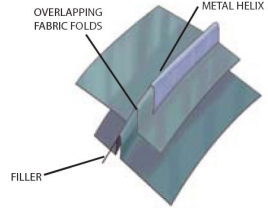
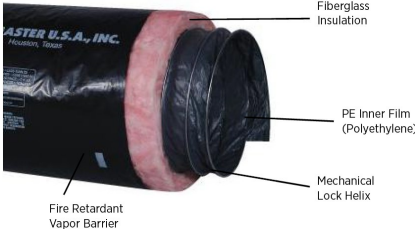

**LINER:** An acoustically transparent PE (Polyethylene) inner film allows mid-range sound energy to penetrate the duct wall. Mechanically Locked without adhesives.

**VAPOR BARRIER:** Black fire retardant Polyethylene material. Excellent strength at low temperatures. Will not age harden.

**HELIX:** Corrosive resistant galvanized steel, formed and mechanically locked to fabric.

**INSULATION:** Fiberglass insulation blanket, factory wrapped.

Available in 25' boxes of 6", 8", 10", 12", and 14" with R6 thermal conductance  
 Flame spread = less than 25, Smoke developed = less than 50

## Flexmaster Type 6 Acoustical Flexible Duct

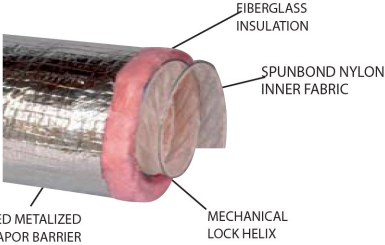

**LINER:** An acoustically transparent Spunbond Nylon fabric allows broadband sound energy to penetrate the duct wall. Mechanically Locked without adhesives.

**VAPOR BARRIER:** Fire retardant reinforced aluminum material. Excellent strength at low temperatures. Will not age harden.

Available in 25' boxes of 6", 8", 10", 12", and 14" with R6 thermal conductance

The insertion loss (dB) of a 6 foot length of duct when tested in accordance with ASTM E 477 at a velocity of 1000 feet per minute shall be at least:

|              | <u>125 HZ</u> | <u>250 HZ</u> | <u>500 HZ</u> | <u>1000 HZ</u> | <u>2000 HZ</u> | <u>4000 HZ</u> |
|--------------|---------------|---------------|---------------|----------------|----------------|----------------|
| 8 inch dia.  | 5             | 10            | 22            | 34             | 22             | 17             |
| 12 inch dia. | 6             | 27            | 22            | 28             | 18             | 11             |

## Flexmaster FlexRight Elbow

Forms flexible duct into highly efficient 90 degree elbows. It is a Universal Mount, 1 piece fully adjustable radius forming brace to support 4" inch through 16" inch diameter flexible ducts. Nylon cable ties secure duct to duct support, (purchased separately and also available in stock)

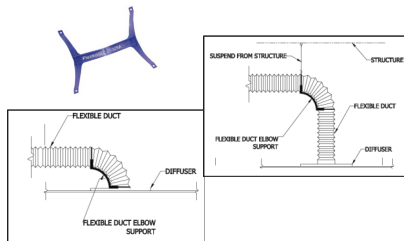

# Northwest Envirofan

## Destratification Fans

- Available in 48" and 56" sizes
- 2-, 5-, 8-Fan Speed Switches
- 30" Extended Down Rods



## Brasch Co

### 24V CO / NO2 Gas Detectors



- Electrochemical Sensors
- Microprocessor Controlled
- Factory Calibrated
- Static Discharge Protection
- Low Voltage Wiring
- Power Loss Fail-Safe
- Easy To Read Display
- Corrosion Resistant Enclosure
- High and Low Alert Level
- Temperature & Humidity Compensation
- Selectable Nitrogen Dioxide Low Level Setpoint
- Adjustable Alert Time Delay
- Remote Alarm Contacts
- 4-10 mA, 0-1 VDC, 0-5 VDC or 0-10 VDC Output

## Aerotech

### Hot Water Radiant Ceiling Panels

- Available in 24"x24" and 24"x48" Lay In Panels
- White Powder Coat Finish



# Detroit Radiant

## Model DET3 Tube Heater

Streamlined for economy and designed without sacrificing performance, the DET3 Series is a quality, energy efficient heater at a more economical price. Detroit Radiant's patented two-stage technology, incorporated into the DET3 Series, provides more comfort while saving valuable energy dollars. Utilizing a direct spark ignition system and hot-rolled steel emitter tubes, this series is the best in this class of equipment.

**Features:**

- Tool-free access to controls.
- Serviceability while unit is operating.
- Separated air and gas burner chamber.
- Symmetrical placement of ignition tube.
- Hinged control compartment provides ease in servicing.
- 3-piece independent compartment cover.
- ABS plastic air intake collar for connection to 4" PVC/DWV pipe.

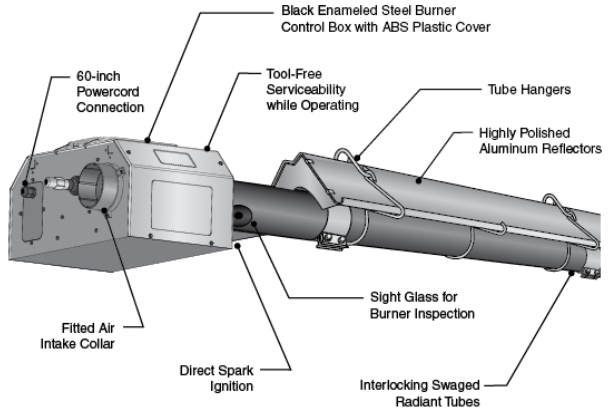

| Tube Heaters | Nominal Length (Ft) | Overall Length | U-Tube Length (w/TF1B) | Typical Mounting Height | Input MBTU/H High/Low | Shipping Weight (LBS) | Power/ Control Voltage |
|--------------|---------------------|----------------|------------------------|-------------------------|-----------------------|-----------------------|------------------------|
| DET3-20-75   | 20'                 | 21'9"          | 13'1"                  | 10'-15'                 | 75/50                 | 120                   | 120V/24V               |
| DET3-30-75   | 30'                 | 31'5"          | 17'9"                  | 11'-18'                 | 75/50                 | 160                   | 120V/24V               |
| DET3-30-100  | 30'                 | 31'5"          | 17'9"                  | 12'-20'                 | 100/65                | 160                   | 120V/24V               |
| DET3-40-100  | 40'                 | 41'1"          | 22'9"                  | 12'-20'                 | 100/65                | 190                   | 120V/24V               |
| DET3-40-125  | 40'                 | 41'1"          | 22'9"                  | 13'-23'                 | 125/82                | 190                   | 120V/24V               |
| DET3-40-150  | 40'                 | 41'1"          | 22'9"                  | 14'-25'                 | 150/100               | 190                   | 120V/24V               |
| DET3-50-125  | 50'                 | 50'9"          | 27'5"                  | 15'-27'                 | 125/82                | 235                   | 120V/24V               |
| DET3-50-150  | 50'                 | 50'9"          | 27'5"                  | 15'-27'                 | 150/100               | 235                   | 120V/24V               |

**Stock Heater Accessories and Parts Available in Stock Include:**

Chain Sets (THCS), Thermostats (TH-PSD22, PSP), Wall Intake Caps ( WIV-4), Sidewall and Roof Vent Kits (4-DSK, 6-DSK, RTVP-4, RTVP-6), Transformers (4000-01V), and 10' and 20' extensions with shields (10HRE, 20HRE)



### Model SRA Small Room Fan Forced Heaters

- Integral Thermostat with 40-85 F Range
- Built In Disconnect Switch
- Standard Recess Mount
- Surface Mount Frame Available



| Model Number | Volts/Phase | Amps | Watts | BTU/HR |
|--------------|-------------|------|-------|--------|
| SRA1012DSF   | 120V/1      | 8.4  | 1000  | 3413   |
| SRA1012DSF   | 120V/1      | 4.2  | 500   | 1706   |
| SRA1512DSF   | 120V/1      | 12.5 | 1500  | 5120   |
| SRA1512DSF   | 120V/1      | 6.3  | 750   | 2560   |
| SRA2024DSF   | 208V/1      | 7.3  | 1500  | 5120   |
| SRA2024DSF   | 208V/1      | 3.6  | 750   | 2560   |
| SRA2024DSF   | 240V/1      | 8.4  | 2000  | 6826   |
| SRA2024DSF   | 240V/1      | 4.2  | 1000  | 3413   |

### Model FRC Commercial Fan Forced Wall Heaters

- Integral Thermostat with 40-90 F Range
- Disconnect, Fan Delay, Thermal Cutout
- Standard Recess Mount
- Surface Mount Frame Available
- Architectural Styling



| Model Number | Volts/Phase | Amps | Watts | BTU/HR |
|--------------|-------------|------|-------|--------|
| FRC4020F     | 208V/1      | 19.2 | 4000  | 13650  |
| FRC4020F     | 208V/1      | 9.6  | 2000  | 6825   |
| FRC4024F     | 240V/1      | 16.7 | 4000  | 13650  |
| FRC4024F     | 240V/1      | 8.3  | 2000  | 6825   |
| FRC4024F     | 208V/1      | 14.4 | 3000  | 10235  |
| FRC4024F     | 208V/1      | 7.2  | 1500  | 5120   |
| FRC4027F     | 277V/1      | 14.4 | 4000  | 13650  |
| FRC4027F     | 277V/1      | 7.22 | 2000  | 6825   |
| FRC4027F     | 240V/1      | 12.5 | 3000  | 10235  |
| FRC4027F     | 240V/1      | 6.3  | 1500  | 5120   |

# Berko

## Model SRA1000 Architectural Small Wall Heaters

- Integral Thermostat with 40-85 F Range
- Built In Disconnect Switch
- Standard Recess Mount
- Surface Mount Frame Available



| Model Number | Volts/Phase | Amps | Watts | BTU/HR |
|--------------|-------------|------|-------|--------|
| SRA1012DSAF  | 120V/1      | 8.4  | 1000  | 3413   |
| SRA1012DSAF  | 120V/1      | 4.2  | 500   | 1706   |
| SRA1512DSAF  | 120V/1      | 12.5 | 1500  | 5120   |
| SRA1512DSAF  | 120V/1      | 6.25 | 750   | 2560   |
| SRA2024DSAF  | 208V/1      | 7.3  | 1500  | 5120   |
| SRA2024DSAF  | 208V/1      | 3.61 | 750   | 2560   |
| SRA2024DSAF  | 240V/1      | 8.4  | 2000  | 6826   |
| SRA2024DSAF  | 240V/1      | 4.2  | 1000  | 3413   |
| SRA2027DSAF  | 277V/1      | 7.3  | 2000  | 6826   |
| SRA2027DSAF  | 277V/1      | 3.61 | 1000  | 3413   |
| SRA2027DSAF  | 240V/1      | 6.25 | 1500  | 5120   |
| SRA2027DSAF  | 240V/1      | 3.2  | 750   | 2560   |

## Model 2500 Electric Baseboard Heaters

- Available in 3', 4', 6', and 8' lengths
- Dual voltage, single phase
- Thermostats available also



# Acudor

## Model UF-5000 Drywall Access Doors



- Universal flush access door for walls and ceilings; designed for installation in drywall, plaster, masonry, tile or any flush surface.
- The door panel features rounded safety corners, which provide an architecturally pleasing appearance.
- The one-piece trim flange will not rack, sag or distort.
- The unique continuous concealed hinge will not bind or corrode, allowing the door to operate freely time and time again.
- For easy installation, the mounting frame is 1 1/4" deep, giving maximum clearance behind the door frame.

Available in sizes:

- 12"x12"
- 18"x18"
- 24"x24"

## Model CD-5080 Duct Access Doors

- Removable, Insulated door panel, along with gasketing between the door and frame
- 5/8" notched knock over tabs on the inside of the frame provide for easy installation
- These doors are designed for use in low to medium pressure up to 3" static W.G.

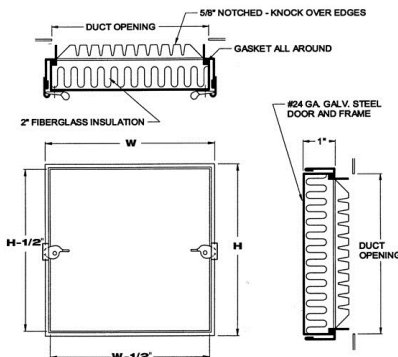
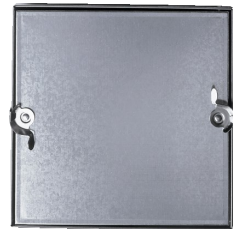

Available in sizes:

- 6"x6"
- 8"x8"
- 12"x12"
- 18"x18"
- 24"x24"



## **AIR FLOW INC.**

8355 W. Bradley Road  
Milwaukee, WI 53223

Phone: 414.351.1999

Fax: 414.351.1933

Website: [www.airflowreps.com](http://www.airflowreps.com)

